



RoHS Compliant

Specifications

Electrical Ratings	See Contact Options
Electrical Life	100,000 cycles typical
Contact Resistance	<50mΩ initial @ 2-4VDC, 100mA
Dielectric Strength	2000Vrms min
Insulation Resistance	>100MΩ min

Operating Force	2 Pole: 350 ± 100gF, 200 ± 100gF
	4 Pole: 450 ± 100gF, 400 ± 100gF
	6 Pole: 550 ± 100gF, 450 ± 100gF
	8~10 Pole: 650 ± 150gF
Operating Temperature	-20°C to 70°C
Storage Temperature	-40°C to 85°C

Materials

Actuator	POM
Housing	PC
Terminal Base	Phenolic
Contacts	Phosphor Bronze, Silver or Gold-Nickel Plated
Terminals	Brass, Silver or Gold-Nickel Plated
Chassis	Steel
Spring	Steel
Latching Pin	Steel

Ordering Information

1. Series	DL	4	S	N	F	B	Q	C13_
DL								
2. Number of Poles	2 = DPDT 4 = 4PDT 6 = 6PDT 8 = 8PDT 10 = 10PDT **Stacking switch part numbers are: DL2LAQ/4LAQ (soft touch = DL2SLAQ/4SLAQ) DL2LAQ/6LAQ (soft touch = DL2SLAQ/6SLAQ)							
3. Actuation Force Options	None = Standard Force S = Soft Touch							
4. Switch Function	N = Non-latching L = Latching							
5. Terminal Options	A, F, E, C, G							
6. Mounting Options	Blank = No Chassis (standard) B = Mounting Chassis, single stage, 3.2mm dia mounting holes C = Mounting Chassis, single stage, M3x0.5 threaded mounting holes **Multi-Stage switch assembly part numbers assigned at factory							
7. Contact Material	Q = Silver R = Gold							
6. Caps					Cap Colors			
Blank = No Cap	C14	C19	C27					
C11	C15	C20	C28					
C12	C16	C22						
C13	C18	C26						
				**See Cap Options for color availability				

Horizontal Pushbutton

Dimensions

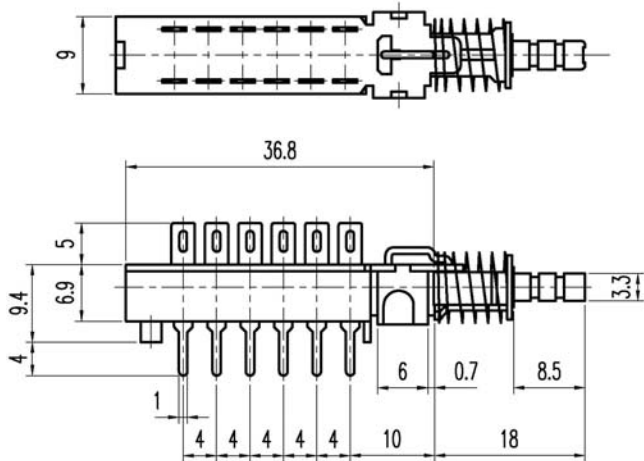

PC Layout

Number of Poles	"L" mm	"P" mm	"A" mm
2	24.8	6	8
4	36.8	12	16
6	48.8	18	24
8	60.8	24	32
10	72.8	30	40

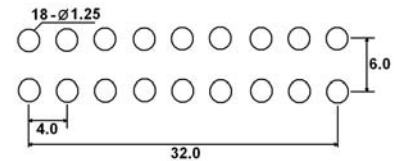

Terminal Options and Actuator Detail

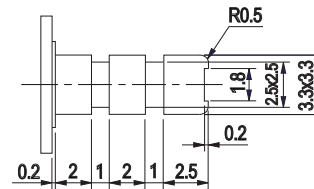
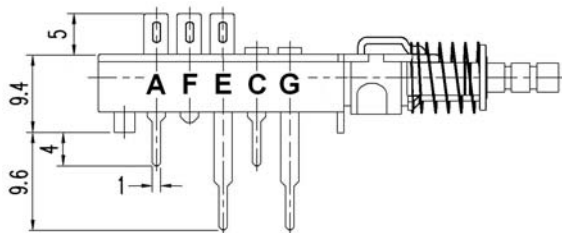

Mounting Options

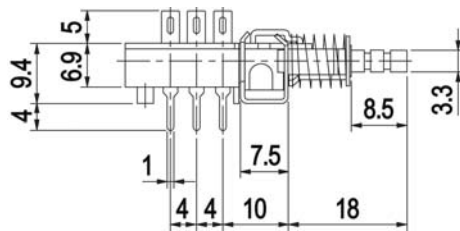

B = 3.2mm mounting holes

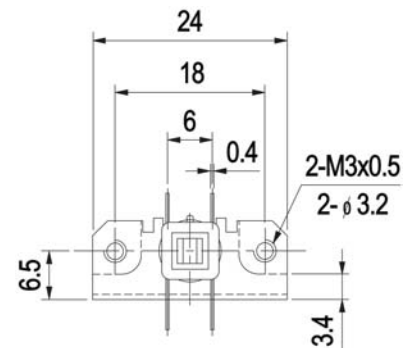

C = M3x0.5 mounting holes

Stacking Switches

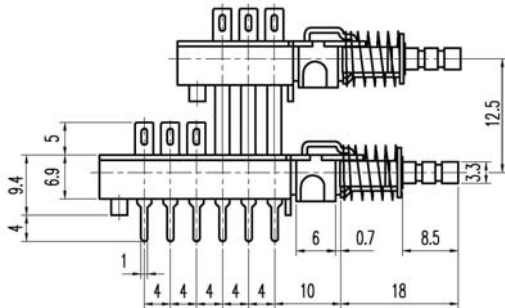

DL2LAQ/4LAQ (soft touch = DL2SLAQ/4SLAQ)

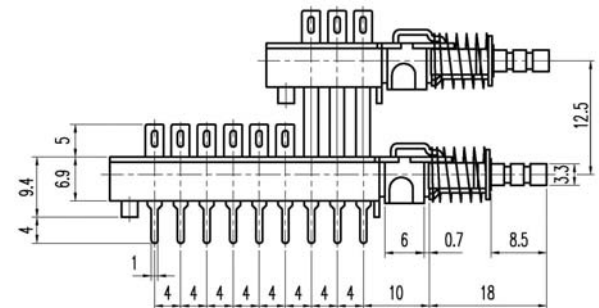

DL2LAQ/6LAQ (soft touch = DL2SLAQ/6SLAQ)

Contact Options

Designator	Contact Material	Terminal Material	Electrical Ratings
Q	Silver Plating	Silver Plating	500mA @ 120VAC, 1A @ 28VDC
R	Gold over Nickel Plating	Gold over Nickel Plating	0.4VA max @ 20VAC or VDC max

Cap Options

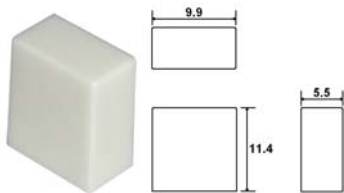

C11_

1 = White, 2 = Black, 3 = Red, 9 = Light Gray
Contact Factory for other available colors

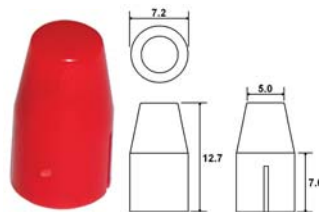

C12_

1 = White, 2 = Black, 3 = Red, 9 = Light Gray
Contact Factory for other available colors

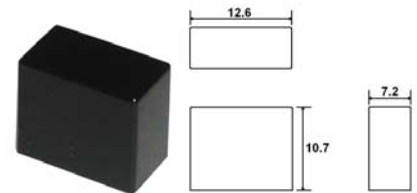

C13_

1 = White, 2 = Black, 3 = Red, 9 = Light Gray
Contact Factory for other available colors

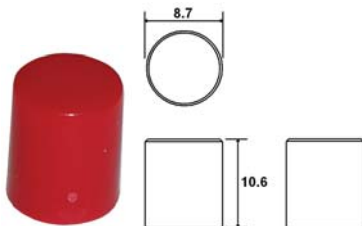

C14_

1 = White, 2 = Black, 3 = Red, 9 = Light Gray
Contact Factory for other available colors

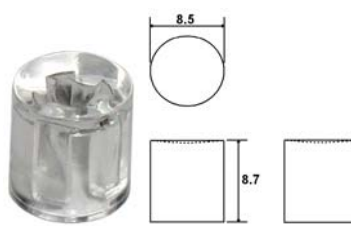

C15_

2 = Black, 0 = Clear
Contact Factory for other available colors

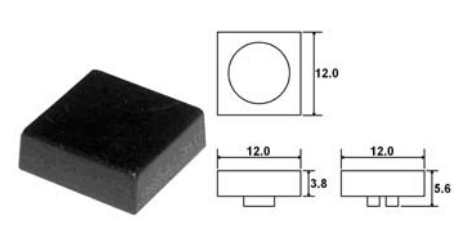

C16_

1 = White, 2 = Black, 3 = Red, 7 = Blue
Contact Factory for other available colors

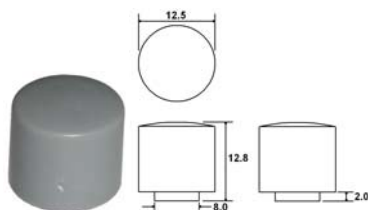

C18_

1 = White, 2 = Black, 9 = Light Gray
Contact Factory for other available colors

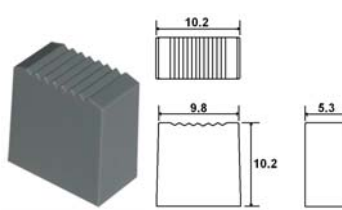

C19_

1 = White, 2 = Black, 3 = Red, 8 = Dark Gray
Contact Factory for other available colors

DL

Horizontal Pushbutton

Cap Options

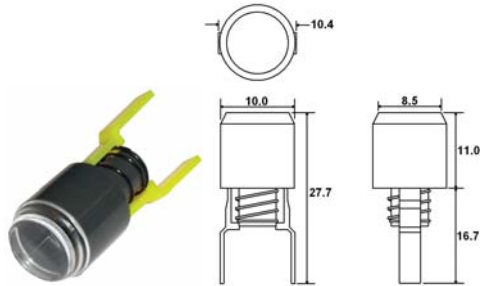

C20_ _

Housing Color : 2 = Black, 9 = Light Gray
 Indicator Color : 1 = White, 4 = Yellow, 5 = Green, 7 = Blue
 Contact Factory for other available colors



C22_ _

2 = Black, 8 = Dark Gray, 9 = Light Gray
 Contact Factory for other available colors

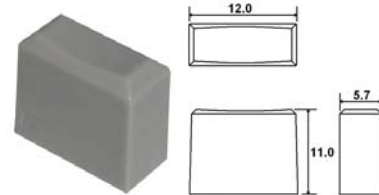

C26_ _

1 = White, 2 = Black, 3 = Red, 9 = Light Gray
 Contact Factory for other available colors

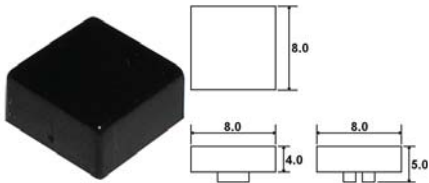

C27_ _

1 = White, 2 = Black, 3 = Red, 9 = Light Gray
 Contact Factory for other available colors



C28_ _

1 = White, 2 = Black, 3 = Red
 Contact Factory for other available colors

Multi-Stage Chassis

Part Numbers assigned at the factory

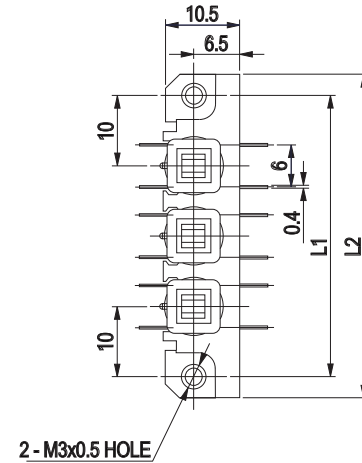
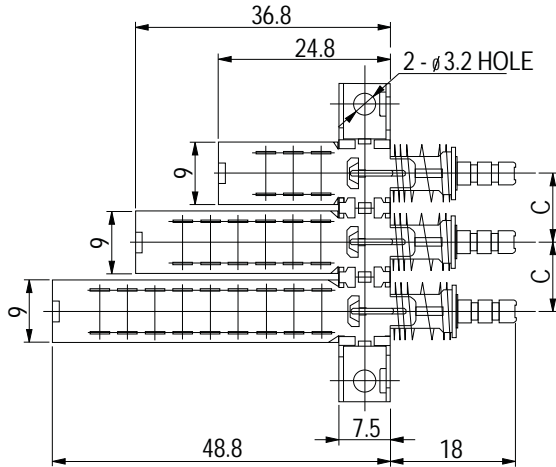

Bracket Length & Mounting Pitch

Pitch (C)	Number of Positions											
	1		2		3		4		5		6	
	L1	L2	L1	L2	L1	L2	L1	L2	L1	L2	L1	L2
10mm	18	24	30	36	40	46	50	56	60	66	70	76
12.5mm			32.5	38.5	45	51	57.5	63.5	70	76	82.5	88.5
15mm			35	41	50	56	65	71	80	86	95	101
17.5mm			37.5	43.5	55	61	72.5	78.5	90	96	107.5	113.5
20mm			40	46	60	66	80	86	100	106	120	126
25mm			45	51	70	76	95	101	120	126	145	151
30mm			50	56	80	86	110	116	140	146	170	176